



Operations Manual

Eagle 2000 Series Stretch Wrapper
Models B, BE, BHS, EB, EBT, BWS



**READ ALL INSTRUCTIONS CONTAINED IN THIS
MANUAL PRIOR TO MACHINE INSTALLATION!**

Contents

	<i>page</i>
1. Machine Safety Information	
1.1 Safety & Warnings	3
1.2 Specifications	5
1.3 Outline & Applications	8
1.4 Position of Operation	8
1.5 Safety Precautions Prior to Operation	8
2. Machine Installation	
2.1 Machine Structure & Main Components	9
2.2 Transportation	10
2.3 Installation	11
2.4 Operational Environment	14
3. Operation	
3.1 Operational Steps & Film Loading	15
3.2 Basic Machine Operation	16
3.3 LCD Screen Operation	17
3.4 LCD Screen Navigation & Language	19
3.5 Password Settings	24
4. Weight Scales (Optional)	
4.1 Introduction	26
4.2 Error Codes	28
5. Maintenance & Troubleshooting	
5.1 Troubleshooting Guide	29
5.2 Carriage Load Safety Switch	31
5.3 Turntable Home Switch	32
5.4 Turntable & Carriage Adjustment	34
6. Illustrations & Parts List	
6.1 Base (Turntable)	35
6.2 Idler Roller	37
6.3 Mast	38
6.4 Carriage	40
6.5 Film Roller	42
6.6 Extended Rollers	43
7. Electrical Schematics	44

1.1 Safety & Warnings

- Before servicing, always power down and unplug the machine from the power source.
- Ensure that the correct voltage is being supplied from the power source.
- Do not touch the turn table while machine is in operation.
- Place all items to be wrapped in the center of the turntable.
- Keep the machine and surrounding area clean, clear and free of debris to ensure safe operation.

Warning Labels



DO NOT MODIFY OR REMOVE WARNING LABELS



Turntable Edge (x2)



Use Caution When Stepping or Walking
(Turntable may move)

Platform



Table Rotation Direction

Platform



Do Not Step

1.1 Safety & Warnings



DO NOT MODIFY OR REMOVE WARNING LABELS



Film Carriage



NO OPEN WHEN RUNNING

Do Not Open While Running



Control Panel (Bottom)

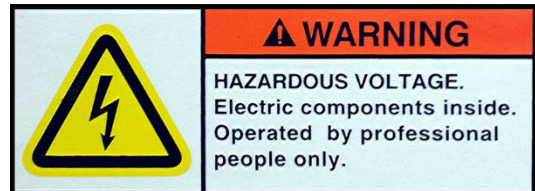

Electrical Hazard

Do not service machine while powered up and connected to power source!

1.2 Specifications - Eagle 2000B

Power Supply	110VAC, 60Hz
Turntable Speed	(Standard 0-12 rpm) (Optional 0-20rpm) ¹
Turntable Motor	1 HP 750W 1420 RPM 220V 1:30 Gearbox
Turntable Diameter	59"
Turntable Diagonal	80"
Turntable Height	3.4"
Turntable Gear	1:5
Turntable Chain	12A-1 ISO
Carriage Up/Down	1/3 HP 1390 RPM 220V 1:60 Gearbox
Carriage Up/Down Chain	08B-1 ISO
Pre-Stretch Motor	1/3 HP 1390 RPM 220V 1:20 Gearbox
Pre-Stretch Gear Ratio	1:12
Pre-Stretch Chain	06B-1 ISO
Film Stretch	250% pre-stretch with adjustable load force
Film Lift	Photo-eye controlled to match pkg height ²
Film Width	20" (standard) or 30" (option)
Adjustable Internal Limit Switches	8" Top & Bottom Rails
Max Film Height	87"
Mast Height	94"
Max Turntable Weight Capacity	5,000lbs
Max Package Height (2" Overlap)	87"
Machine Dimensions	96.5" X 59" X 99"
Shipping Weight	1,295lbs
Attachment	Ramp or Custom Heavy Duty ³
Noise	≤75 DB
Environment	Humidity ≤98% Temperature 32-104°F

¹ Note: Black product requires custom photo-eye installation.

² Factory ramp is for use with hand pallet jacks only. Maximum combined weight of jack and product must not exceed 1,300lbs. Custom heavy-duty ramps are available for use with loads exceeding 1,300lbs. (See page 5 for details)

³ Turntable maximum RPM can be increased to 20 RPM upon request.

1.2 Specifications - Eagle 2000BE

Power Supply	110VAC, 60Hz
Turntable Speed	(Standard 0-12 rpm) (Optional 0-20rpm) ¹
Turntable Motor	1 HP 750W 1420 RPM 220V 1:30 Gearbox
Turntable Diameter	59"
Turntable Diagonal	80"
Turntable Height	3.4"
Turntable Gear	1:5
Turntable Chain	12A-1 ISO
Carriage Up/Down	1/3 HP 1390 RPM 220V 1:60 Gearbox
Carriage Up/Down Chain	08B-1 ISO
Pre-Stretch Motor	1/3 HP 1390 RPM 220V 1:20 Gearbox
Pre-Stretch Gear Ratio	1:12
Pre-Stretch Chain	06B-1 ISO
Film Stretch	250% pre-stretch with adjustable load force
Film Lift	Photo-eye controlled to match pkg height ²
Film Width	20" (standard) or 30" (option)
Adjustable Internal Limit Switches	8" Top & Bottom Rails
Max Film Height	120"
Mast Height	126.5"
Max Turntable Weight Capacity	5,000lbs
Max Package Height (2" Overlap)	118"
Machine Dimensions	96.5" X 59" X 130"
Shipping Weight	2,060lbs
Attachment	Ramp or Custom Heavy Duty ³
Noise	≤75 DB
Environment	Humidity ≤98% Temperature 32-104°F

¹ Note: Black product requires custom photo-eye installation.

² Factory ramp is for use with hand pallet jacks only. Maximum combined weight of jack and product must not exceed 1,300lbs. Custom heavy-duty ramps are available for use with loads exceeding 1,300lbs. (See page 5 for details)

³ Turntable maximum RPM can be increased to 20 RPM upon request.

1.2 Specifications - Eagle 2000EBT

ITEM	SPECIFICATION EAGLE 2000EBT
Power Supply	110VAC, 60Hz
Turntable Speed	(Standard 0-12 rpm) (Optional 0-20rpm) ¹
Turntable Motor	1 HP 750W 1420 RPM 220V 1:30 Gearbox
Turntable Diameter	78.5
Turntable Diagonal	170"
Turntable Height	3.4"
Turntable Gear	1:5
Turntable Chain	12A-1 ISO
Carriage Up/Down	1/3 HP 1390 RPM 220V 1:60 Gearbox
Carriage Up/Down Chain	08B-1 ISO
Pre-Stretch Motor	1/3 HP 1390 RPM 220V 1:20 Gearbox
Pre-Stretch Gear Ratio	1:12
Pre-Stretch Chain	06B-1 ISO
Film Stretch	250% pre-stretch with adjustable load force
Film Lift	Photo-eye controlled to match pkg height ²
Film Width	20" (standard) or 30" (option)
Adjustable Internal Limit Switches	8" Top & Bottom Rails
Max Film Height	12"
Mast Height	126.5"
Max Turntable Weight Capacity	5,000lbs
Max Package Height (2" Overlap)	118"
Machine Dimensions	151" X 78.5" X 130"
Shipping Weight	2125lbs
Attachment	Ramp or Custom Heavy Duty ³
Noise	≤75 DB
Environment	Humidity ≤98% Temperature 32-104°F

¹ Note: Black product requires custom photo-eye installation.

² Factory ramp is for use with hand pallet jacks only. Maximum combined weight of jack and product must not exceed 1,300lbs. Custom heavy-duty ramps are available for use with loads exceeding 1,300lbs. (See page 5 for details)

³ Turntable maximum RPM can be increased to 20 RPM upon request.

1.3 Outline and Application Field

This machine features a PLC controller. The electric subassembly uses world famous products such as OMRON, LG and TE components. This provides a reasonable, high reliability and convenient use for the machine. It can advance production efficiency and prevent goods from being damaged during transportation. This machine has a wide range of applications and is used in the following industries: chemical, fiber, tobacco, pharmaceutical, publishing, refrigeration, etc.

1.4 Position of Operation

The operator must stand in front of the operating screen, away from the turntable and carriage. The operator must insure that no other individual or devices such as the forklift are at risk during operation. (See Fig. 1-1)

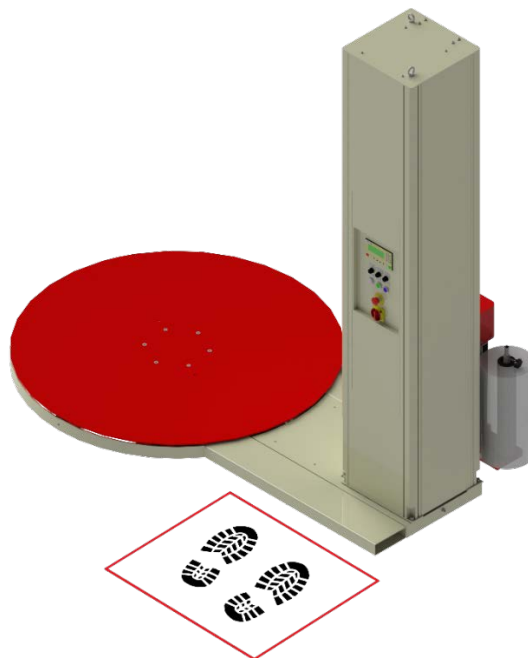

Fig. 1-1

1.5 Safety Precautions Prior to Operating Machine

- This machine uses 110V, 60Hz, single phase power.
- Do not plug into an extension cord.
- Do not step on the machine when it is running.
- Do not install this machine on soft ground.
- Install on a level surface.
- Do not put the object to be wrapped on the edge of the turntable.
- Turn off the power after done using the machine.
- In an emergency, press the emergency stop button. This will cease movement of the machine.
- Clean the machine once a day.
- Only a Qualified Technician should change or test the wiring and/or electrical components.
- **DO NOT** push, drag, or slide machine! Doing so will cause severe damage!

2.1 Machine Structure & Components Illustration

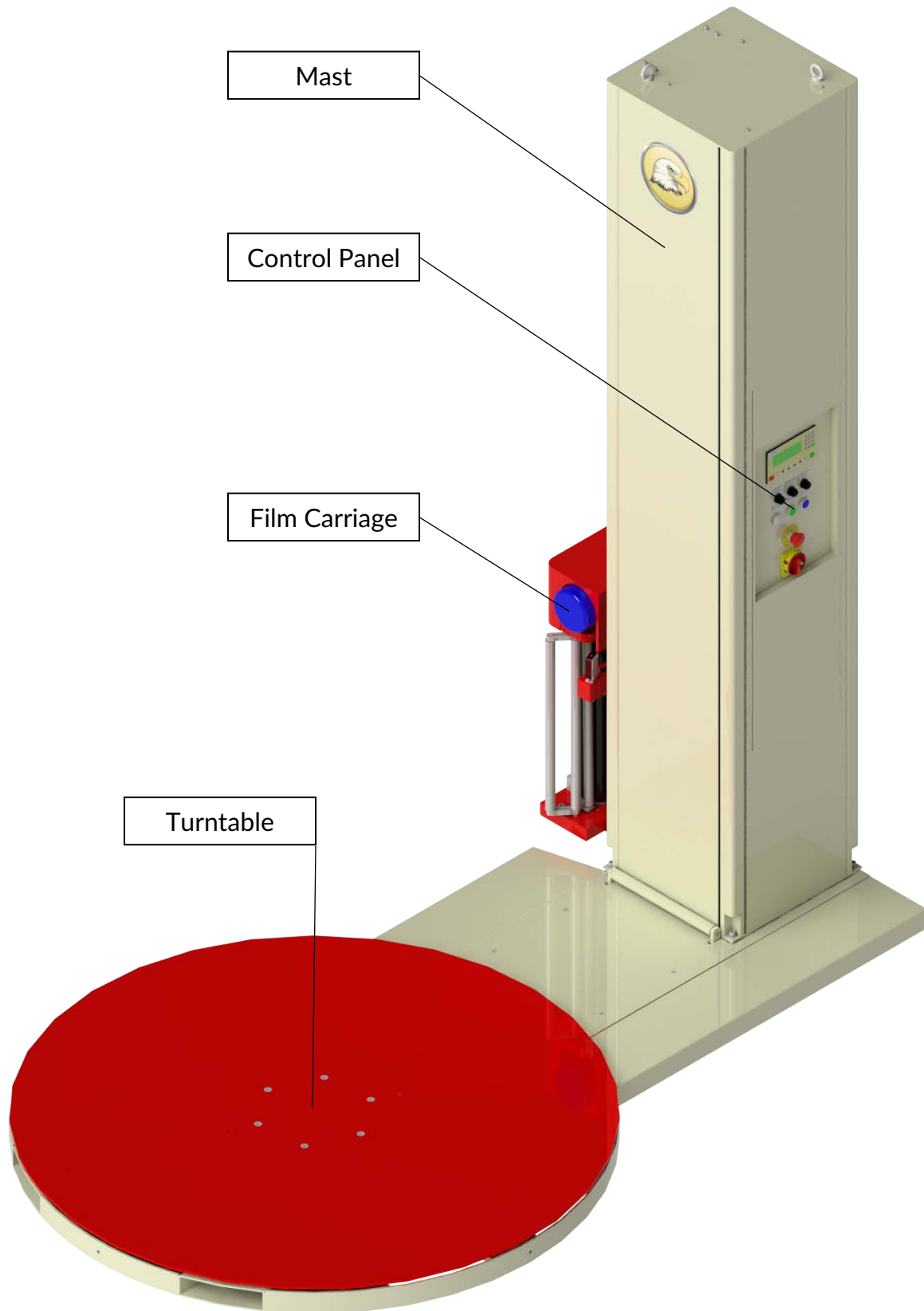

Fig. 2-1

2.2 Transportation

You must have at least 4ft fork tubes or tube extensions fully inserted into the machine and a forklift rated for 3,000lbs to transport the machine safely. Do not raise the load more than 6" off of the ground. (See Fig. 2-2)



ALWAYS USE OSHA HANDLING PROCEDURES FOR HANDLING THE STRETCH WRAPPER AND REMEMBER TO NEVER PUSH, DRAG, OR SLIDE THE MACHINE!



Do not transport machine from turntable when mast is lowered!

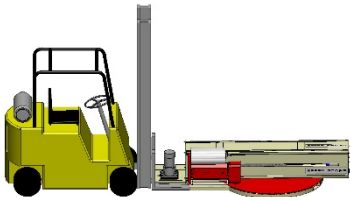

When transporting the machine in this configuration;
1. Inspection cover must be removed before raising or lowering the mast.
2. Carriage must be raised 8 inches

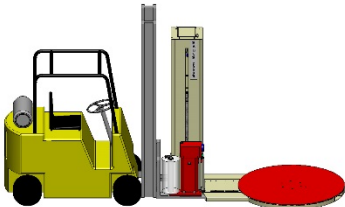

Carriage must be raised 6~8 inches before attempting to lift machine from this end.

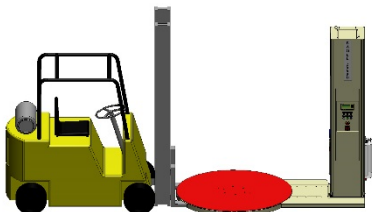

It is acceptable to transport machine by turntable when mast has been raised.

Fig. 2-2

2.3 Installation

Step 1 - Place the machine in the desired location using a tow motor or crane capable of handling a load of 3,000lbs. (See Fig. 2-3)

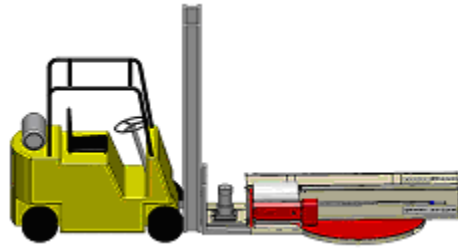

Fig. 2-3

Step 2 - Remove the lower rear inspection panel on the mast prior to raising the mast. The panel is located on the end of the machine next to the turntable motor. The panel has a warning label affixed to it. (See Fig. 2-4a & Fig. 2-4b)

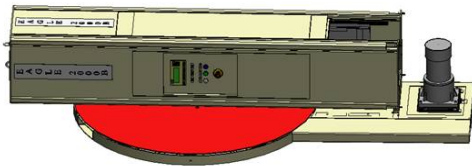

Fig. 2-4a

WARNING
MUST FOLLOW THE
INSTALLATION
INSTRUCTIONS ON PGS 4-7
IN THE MACHINE MANUAL.
FAILURE TO DO SO COULD
CAUSE DAMAGE AND VOID
WARRANTY. THIS PANEL
MUST BE REMOVED PRIOR
TO STANDING UP THE
MACHINE.

WARNING
Fig. 2-4b

Step 3 - Lift the mast using hoisting tools. A tow motor or hoist rated for at least 3,000lbs is required. While lifting the mast, use caution to ensure that wires and connectors are not pinched. (See Fig. 2-5a)

Once the machine is fully upright, one individual can stabilize the mast while a second individual fastens the four M10 bolts to secure the mast to the base. The M10 bolts are to be tightened to 30ft/lbs of torque. (See Fig. 2-5b)

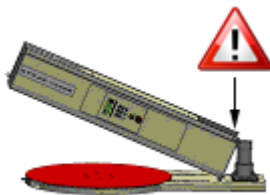

Fig. 2-5a

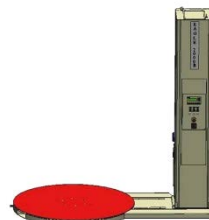

Fig. 2-5b

2.3 Installation

Step 4 - If installing a ramp, place the ramp by locating the ramp shoulder bolt and placing it into the slot in the ramp. It is highly recommended to anchor the ramp to the floor. (See Fig. 2-6)

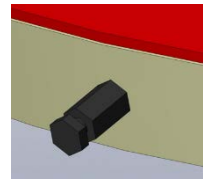

Fig. 2-6

Step 5 - Affix the carriage onto the corresponding position on the mast and fasten with four M8 bolts. (See Fig. 2-7) Insert the connector plugs on the front of the carriage into the receptacles. (See Fig. 2-8) Do not force the connectors together.

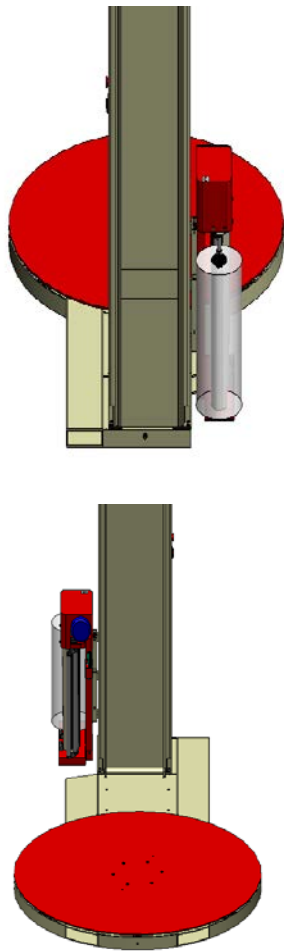

Fig. 2-7



Fig. 2-8*

2.3 Installation

Step 6 - Insert the connector plug inside the bottom of the mast into the corresponding receptacles. (See Fig 2-9a, 2-9b, 2-9c)



Fig. 2-9a



Fig. 2-9b



Fig. 2-9c

Note: These connectors are for carriage motor power (pre-stretch), photo-electric eye, home limit switch, and E-Stop switch located on the bottom of the carriage.

Step 7 - Fasten the lower rear panel into the corresponding position on the post using the pin. (See Fig. 2-10)

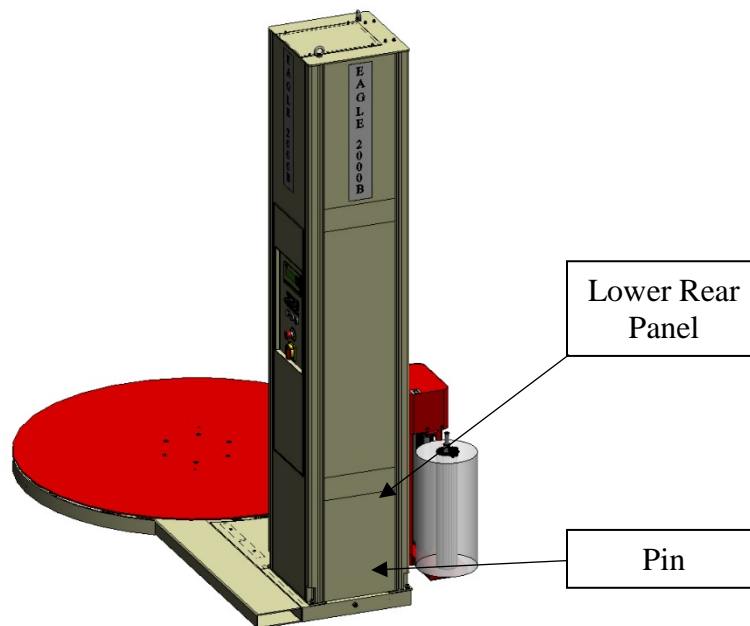

Fig. 2-10

Step 8 - Verify that all screws are tight and then turn on the power. Check to see if the power indicator is on and that text is displayed on the LCD screen.

2.4 Operational Environment

- Machine should be far from smoke, preferably in a dry, well-ventilated area.
- Normal environment temperature should be within 32°F and 104°F.
- No special requirements for electromagnetic radiation.
- Machine should not be placed under direct lighting as it may cause photoelectric eye to malfunction.
- **DO NOT** push, drag, or slide machine! Doing so will cause severe damage!

Note: If product to be wrapped is a dark color (black, dark blue, etc...), the standard photoelectric eye may not work properly. A photo-eye upgrade option is available for sensing dark objects.

3.1 Operational Steps & Film Loading



BEFORE LOADING FILM, PRESS THE EMERGENCY STOP BUTTON AND TURN THE POWER SWITCH TO THE OFF POSITION

Loading stretch film into carriage

- Step 1** - Loosen fastening screw "A" and take off roll holder "B". (See Fig. 3-1)
- Step 2** - Center the film core over the film shaft and lower onto the lower orientation plate "C" of the film shelf. (See Fig. 3-1)
- Step 3** - Mount roll holder "B" and re-tighten fastening screw "A". (See Fig. 3-1)
- Step 4** - Push down handle "E" to open carriage door. Then press the film through in the direction of the arrow and close the door (do not slam). Pass the film behind and around the first roller and then between the first and second roller. (See Fig. 3-3)

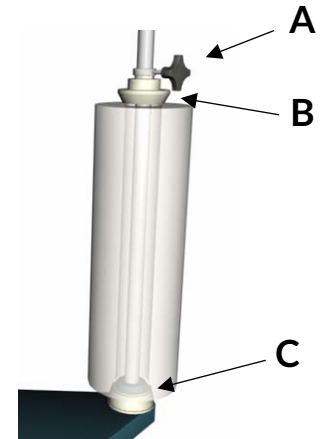

Fig. 3-1



Fig. 3-2

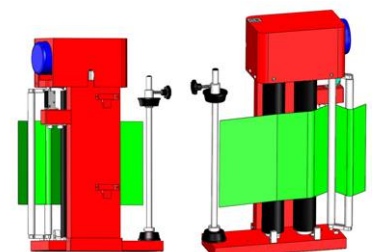
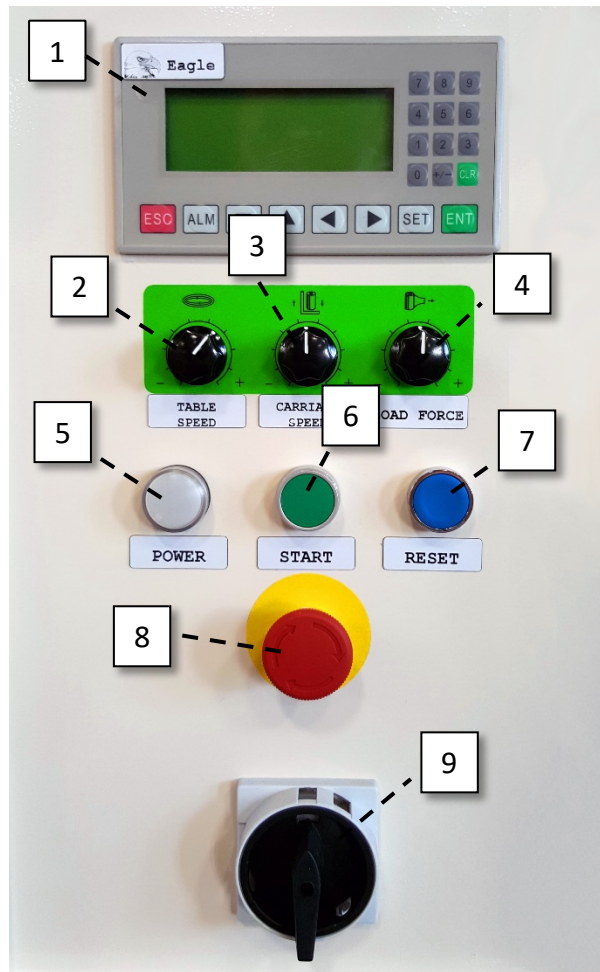

Fig. 3-3

Note: Do not slam or force the carriage door closed. Doing so may cause damage to hinges and carriage door locking mechanism. Do not use sharp objects on or near rollers as they can be easily damaged.

3.2 Basic Machine Operation



1. Screen Controller	6. Start Button
2. Table Speed	7. Reset Button
3. Carriage Speed	8. Emergency Stop Button
4. Load Force	9. Power Switch
5. Power Indicator	

The turntable speed and load force knobs can be adjusted to achieve desired film tension.

The speed and load force work in conjunction. If the table speed is increased, the load force will need to be decreased to maintain the same film tension. If the table speed is decreased, the load force will need to be increased to maintain the same film tension.

3.2 Basic Machine Operation

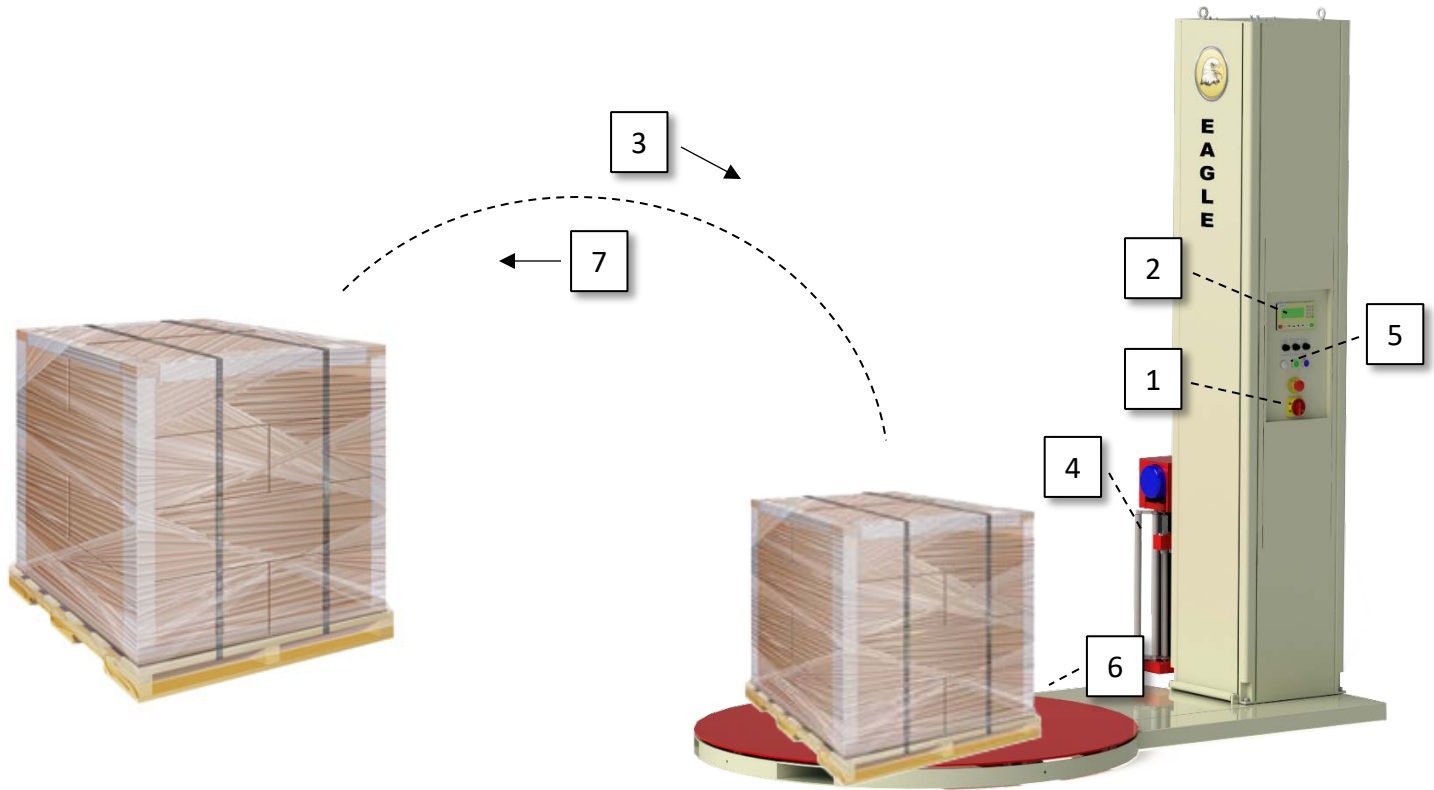

Step 1 – Turn on the power to the machine.

Step 2 – Using the Screen Controller, select a job mode.

Step 3 – Place the load to be wrapped onto the turntable.
Once the load has been placed onto the turntable and detected, the screen notifier will change from “No Load Detected” to “Machine Ready”.

Step 4 – Connect the loose end of the stretch film to the bottom of the load (ie: corner of the pallet)

Step 5 – Press the start button to begin wrapping the load.

Step 6 – Once the job finishes, split the film between the stretch wrapper and the now wrapped load and secure any loose ends of film.

Step 7 – Remove the load from the turntable and place the next load onto the turntable.
Repeat steps 2-7 as required

3.3 LCD Screen Operation

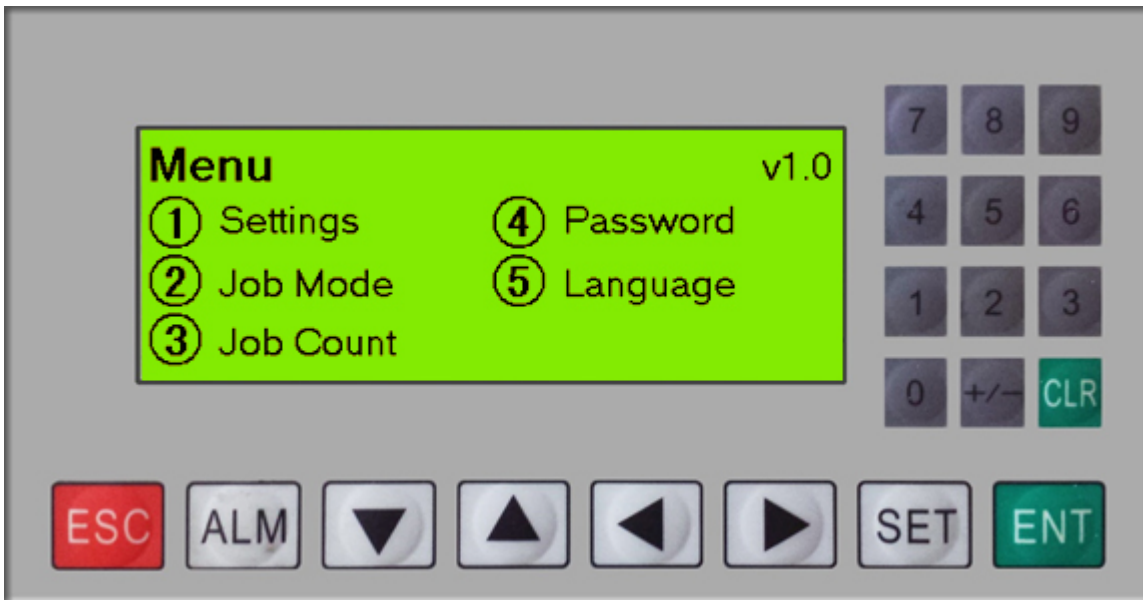

The LCD screen displays information used to control the machine and to make changes to operational parameters. Active keys are shown with a circle or square around them. Pressing the corresponding key will execute the function.

To change a setting, press the **SET** button.

Use the left and right **◀ ▶** arrows to move the cursor to the value/item to be changed.

Numeric values can be entered using the number pad or by scrolling through preset values using the up and down arrows **▲ ▼**.

When applicable, the left and right arrows **◀ ▶** can be used to previous/next positions within a field.

Once the desired value has been entered, press **ENT** to save any changes.

*Note: Pressing **SET** will not save changes at this point.*

Pressing the **ESC** key will go back to the previous screen.

3.4 Navigating LCD Screens

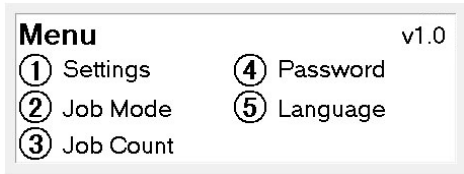

Menu

From this screen, you can navigate to;

① Settings

Machine settings and delay timers

② Job Mode

Auto, Manual, Single Wrap, Top Wait, Slow Wrap

③ Job Count

View number of completed job cycles have been run for the shift and cumulative total.

④ Password

Set machine password.

⑤ Language

Change menu language.

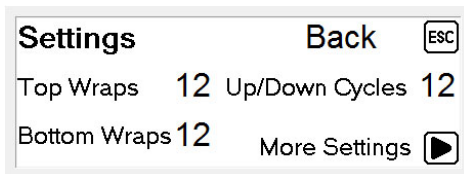

Settings – page 1

From this screen, you can set the number of wraps to complete at the top and bottom of the load. Additionally, the number of up/down cycles can be set from this screen.

Press the button to view page 2.

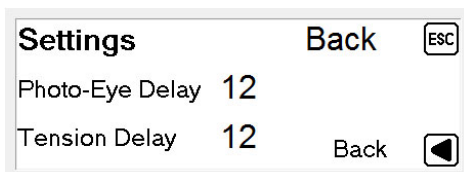

Settings – page 2

From this screen, you can change how far past the top of the package the film will be applied.

To change the settings, press , enter the amount of time in tenths of a second (ie; 15=1.5 seconds). Press , enter a value for the highlighted item and press to save and move the cursor to the next field.

Press the button to view page 1.

3.4 Navigating LCD Screens



Job Mode

From this screen, you can select the different types of modes the machine has.

To the bottom left of the screen, there is a text notifier that displays machine status.

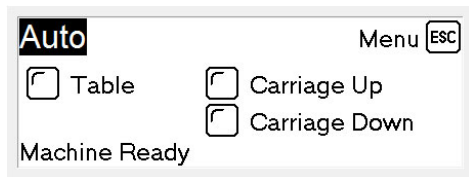

Job Mode / Auto

This mode is used to automatically wrap packages.

To begin, press the **Start** button

The machine will wrap around the package once at the bottom and the carriage will begin traveling up to the height of the package. At the top of the package, the machine will wrap the number of times set in the top cycle parameter and then the carriage will travel to the bottom of the package and wrap the number of times set in the bottom cycle parameter.

To the bottom left of the screen, there is a text notifier that displays machine status.



Job Mode / Manual

This mode is used when you need to wrap goods by hand or use the machine as a turntable.

- ① **Table** - Start/Stop turntable rotation
- ② **Up** - Start/Stop carriage travel up
- ③ **Down** - Start/Stop carriage travel down

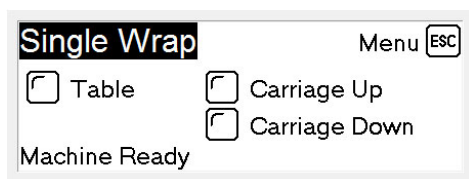

Job Mode / Single Wrap

This mode is used when only one upward wrap is required.

To begin, press **Start** button

The machine will wrap the package once at the bottom. The carriage will travel up to the top of the package, wrap the number of times set in the top cycle parameters and the turntable will stop. The carriage will then travel back down to the bottom.

To the bottom left of the screen, there is a text notifier that displays machine status.

3.4 Navigating LCD Screens

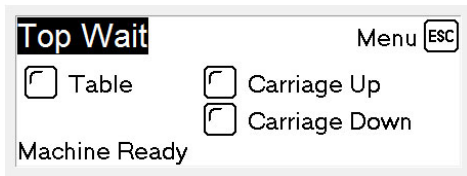

Job Mode / Top Wait

This mode is used when a cover will be placed on the top of the package.

To begin, press **Start** button

The machine will wrap the package once at the bottom and the carriage will travel to the top of the package and pause for the operator to place a cover on the package. To continue, press the **Start** button. The machine will wrap the number of times set in the top cycle parameter and the carriage will travel back down to the bottom of the package where it will wrap the number of times set in the bottom cycle parameter.

To the bottom left of the screen, there is a text notifier that displays machine status.



Job Mode / Slow Wrap

This mode is used when wrapping a tall unstable load.

To begin, press **Start** button

The machine will wrap around the package with a slow turntable rotation speed and low tension. Once the carriage reaches the top of the package, it will change to a normal tension cycle based on the preset parameters and continue wrapping to the bottom of the package.

To the bottom left of the screen, there is a text notifier that displays machine status.

3.4 Navigating LCD Screens

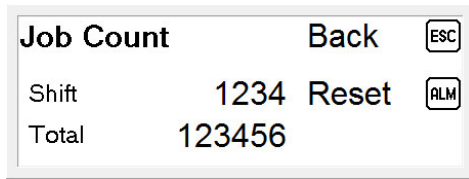

Job Count

This screen displays the current number of cycles and the total number of cycles of the machine.

To reset the current yield, press the  key

Set Menu Language

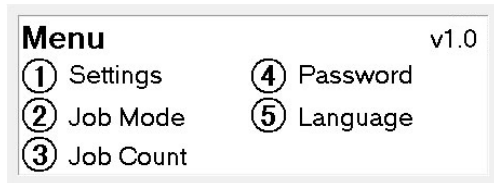

From the Main Menu, select ⑤ **Language**



To change the language, select either;

- ① English
- ② Spanish

E-STOP



If the machine has been placed in E-STOP, this screen will be displayed.



Once the E-STOP condition has been cleared, a screen indicating that a reset is required will be displayed.

Film Tension Lost



If film tension is lost during a job, the machine will pause the job and display a screen indicating film tension has been lost. Once film tension has been restored, the job can be continued by pressing the **Start** button.

3.4 Navigating LCD Screens

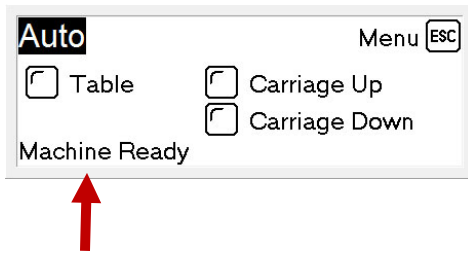

Job Notifiers

At the bottom-left corner of the auto and semi-auto job screens, there is a textual display of the status of the machine. A few examples of text that may be displayed are;

Machine Ready

A load has been detected as being placed on the turntable and the machine is ready to run the selected job mode.

In Cycle

“In Cycle” will be displayed during operation of the selected job mode.

Load Not Preset

The machine is ready to run the selected mode, but no load has been detected as being placed on the turntable.

Film Carriage Not Home ... Press RESET

The film carriage has not returned to its home position at the bottom of the mast.

Machine Reset – In Progress

This message will be displayed after pressing the reset button on the machine control panel. Once the machine reset process has completed, this message will be cleared from the screen.

3.5 Password Settings



FACTORY DEFAULT PASSWORD: 1234

IF DEFAULT PASSWORD IS CHANGED AND FORGOTTEN, THE ONLY MEANS OF RESET IS BY ON-SITE SERVICE CALL OR PLC REPLACEMENT ALL ASSOCIATED EXPENSES AND FEES WILL BE THE RESPONSIBILITY OF THE MACHINE OWNER

Setting a New Password

Menu		v1.0
① Settings	④ Password	
② Job Mode	⑤ Language	
③ Job Count		

Press **ESC** until the Main Menu is displayed

Press ④ **Password**

Set Password		Back	ESC
Old	12345	<input type="checkbox"/>	
New	12345	Error	OK ALM

Press **SET**

Enter your new password using the numeric keypad.

Press **ENT**

Note: For security reasons, a random generated number will be displayed in place of your new password.

Enter the old password using the numeric keypad.

Note: If you have not previously set up a password, use the factory default password.

Press **ENT**

Note: For security reasons, a random generated number will be displayed in place of your old password.

3.5 Password Settings

Set Password	
Old	12345
New	12345
	Save ALM
	Invalid PW
	See Manual

If there is a error during the process, the screen will display "INVALID PW, SEE MANUAL"

Press **ALM** to clear the error.

Note: If this message is displayed, the new password has not been set. You will need to re-enter the new and old passwords again.

How to Enter a Password

Input password:	
12345	Press 'SET'
	Enter Password
	Press 'ENT'

Any time a menu item is selected that is password protected, the Input Password screen will be displayed.

To enter a password, press **SET**

The black background behind the number will clear to indicate the system is ready for password entry.

Use the numeric keypad to enter your password.

Note: The factory default password is; 1234

Press **ENT** and, if the correct password was entered, the menu will proceed to the item selected.

4.1 Weight Scale - Introduction & System Overview



Key	Operation / Function
ON / OFF	<ul style="list-style-type: none"> Turns Scale On / Off <i>Press and hold for 2+ seconds to operate</i>
Hold	<ul style="list-style-type: none"> Hold Weight on Scale (Manual Hold) <i>Press 'Hold' with scale loaded.</i> Hold Peak Weight (Auto Hold) <i>Press 'Hold' prior to loading scale. Can be used for multiple package weighing or unstable loads.</i> Release Hold Function <i>Press 'Hold' again to return to normal operation.</i> Return (Settings Mode) <i>Previous</i>
	<ul style="list-style-type: none"> Settings Mode: Return

4.1 Weight Scale - Introduction & System Overview

<p>Total</p>	<ul style="list-style-type: none"> ▪ Add Weights <i>With package on the scale, press the 'Total' key to enter weight and retain in memory. Press 'Total' after weighing each package to add weight to cumulative total.</i> ▪ View Total <i>Press 'Total' and 'Print' key at the same time. The total weight value will flash continuously.</i> ▪ Exit Total Mode <i>Press and hold the 'Total' key to display "Clr n".</i> <i>Clear Totals - Press 'Zero' key to display "Clr y", then press 'Print' key</i> <i>Keep Totals - Press 'Print' key while "Clr n" displayed</i> <hr/> <ul style="list-style-type: none"> ▪ Settings Mode: Previous / Home <i>First press = Previous</i> <i>Second press = Home</i>
<p>kg/lb</p>	<ul style="list-style-type: none"> ▪ Change Display from Kilograms to Pounds <hr/> <ul style="list-style-type: none"> ▪ Settings Mode: Left Arrow
<p>Print</p>	<ul style="list-style-type: none"> ▪ Print Totals <i>While in View Totals Mode (See - Total: View Total), press and hold 'Print' for 3 seconds to print.</i> <i>(Optional Printer Hardware Required)</i>

4.2 Weight Scale - Error Codes

Error Code	Possible Cause	Solution
uuuuuu	<ul style="list-style-type: none"> ▪ Overloaded condition. ▪ Wrong connection at load cell. ▪ Load cell has quality problem. 	<ul style="list-style-type: none"> ▪ Reduce the weight. ▪ Check load cell connection. ▪ Inspect load cell for damage. ▪ Check the input and output.
nnnnnn	<ul style="list-style-type: none"> ▪ Overloaded condition. ▪ Bad connections. ▪ Load cell has quality problem. 	<ul style="list-style-type: none"> ▪ Check scale is resisted or not, foot is kept level or not. ▪ Check load cell connection. ▪ Check input and output resistance of load cell.
ERR1	<ul style="list-style-type: none"> ▪ Overweight calibration error. ▪ Incorrect weight input or incorrect weight on weighing platform. 	<ul style="list-style-type: none"> ▪ Input weight correctly during calibration. ▪ Place correct weight on weighing platform.
ERR2	<ul style="list-style-type: none"> ▪ Underweight calibration error. ▪ Incorrect weight input or incorrect weight on weighing platform. 	<ul style="list-style-type: none"> ▪ The calibration weights Minimum is 10% of Max. cap. Recommend 60%-80% of Max. Capacity.
ERR3	<ul style="list-style-type: none"> ▪ During calibration, the input signal is negative. 	<ul style="list-style-type: none"> ▪ Check all connections. Check load cell. If connections and load cell are okay, PCB needs replacing.
ERR4	<ul style="list-style-type: none"> ▪ During calibration, the signal is unstable. 	<ul style="list-style-type: none"> ▪ After the platform is stable, start calibration.
ERR5	<ul style="list-style-type: none"> ▪ Circuitry error 	<ul style="list-style-type: none"> ▪ Replace the PCB.
ERR6	<ul style="list-style-type: none"> ▪ System error 	<ul style="list-style-type: none"> ▪ Call for Tech Support

5.1 Troubleshooting Guide

Error Code	Possible Cause	Solution
Machine will not function	<ul style="list-style-type: none"> ▪ Machine not plugged in. ▪ Outlet where Machine is plugged into has no power or bad outlet. ▪ Power cord has been damaged. ▪ Machine internal circuit breaker tripped. 	<ul style="list-style-type: none"> ▪ Plug machine into 110VAC outlet. ▪ Check to see if outlet has power. ▪ Call service for new cord. ▪ If machine breaker is tripped call tech support.
Machine has power and will not function "Machine Pause"	<ul style="list-style-type: none"> ▪ Input signal 05 is lit on PLC. ▪ E-stop is pushed on main panel. ▪ Carriage base safety switch pushed. ▪ Film Feed Door is not closed properly. ▪ Drive display should display "rdy" for them to be ready. 	<ul style="list-style-type: none"> ▪ Check all E-stop and debris under carriage. ▪ Adjustment may be needed to carriage safety switch reference 4.2 carriage maintenance . ▪ Close door with a firm push Do Not slam or force. ▪ If drive don't display "rdy" call tech support.
Machine will not stop at home	<ul style="list-style-type: none"> ▪ Input signal 03 is not lit on PLC. ▪ Bad connection between mass and turn table. ▪ Bad Limit Switch/ Adjustment. 	<ul style="list-style-type: none"> ▪ This Input will only illuminate when the Limit Switch is on the cam location. ▪ Tighten or replace connector ensure that their no pinched wires. ▪ Replace Limit Switch or adjust so that rides on cam properly.
Machine will not start job after reset	<ul style="list-style-type: none"> ▪ Input 04 is not lit . ▪ Photoelectric Eye is not reading package. 	<ul style="list-style-type: none"> ▪ Photoelectric Eye is not sending a signal to PLC. ▪ Ensure that the both green and amber are illuminated with load in place. ▪ Call tech support
Screen displays Chinese lettering	<ul style="list-style-type: none"> ▪ DB9 connector has come unplugged or is loose. ▪ DB9 connector is bad. 	<ul style="list-style-type: none"> ▪ Tighten connector on PLC and Screen / Be sure to check power connections as well. ▪ Replace DB9 Connector / call tech support .

5.1 Troubleshooting Guide

Problem	Possible Causes	Solution
Carriage does not run	<ul style="list-style-type: none"> ▪ Check to see if the machine is plugged in. ▪ Check carriage speed knob is at minimum position – if so turn carriage speed knob to a higher setting. ▪ Check to see if the chain is broken or disconnected. ▪ Carriage sliding block is jammed – realign slide block. 	<ul style="list-style-type: none"> ▪ Plug machine into adequate power 110 Volt outlet. ▪ Replace chain or reinstall chain / remove any debris. ▪ Loosen slider blocks to realign and lubricate with a dry lube. ▪ Adjust speed potentiometer to correct speed.
Film breaks	<ul style="list-style-type: none"> ▪ Speed is not set well between load force and turntable speed – adjust the settings. ▪ Check for cuts in film. ▪ Move dancer bar without film to see if motor turned on. ▪ Pre-stretch chain is broken or jammed – reinstall chain or refasten chain wheel. 	<ul style="list-style-type: none"> ▪ Replace roll of film. ▪ Faulty drive / look for rdy on display. May need replaced. ▪ Replace chain or reinstall chain and tighten all hardware. ▪ Adjust speed potentiometer to correct speed.
Scale does not work	<ul style="list-style-type: none"> ▪ Is the machine level. ▪ Are all of the leveling feet in the proper place? 	<ul style="list-style-type: none"> ▪ Start by placing the machine on a flat surface and using a level. ▪ Using the leveling feet supplied and screw into load cell.
Notes:		

5.2 Carriage Load Safety Switch



**USE EXTREME CAUTION WHEN ADJUSTING
CARRIAGE SWITCH AS IT CAN BE DAMAGED
BY OVER ADJUSTMENT**

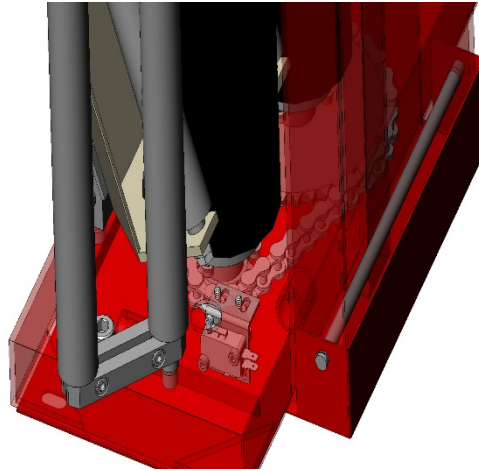

Step 1 - Open Carriage Door

Step 2 - Unload any and all stretch film from machine

Step 3 - Loosen jam nut

Step 4 - Loosen bolt in small increments to avoid damage to switch

Step 5 - Close carriage door gently (Do not install stretch film)

Step 6 - If the machine is able to reset, then the carriage door switch is adjusted correctly. If the machine does not reset, then repeat steps 4 & 5

Step 7 - Open carriage door and tighten jam nut

Step 8 - Reinstall stretch film

5.3 Turntable Home Switch



BE SURE TO DISCONNECT ALL POWER TO THE MACHINE PRIOR TO ANY MAINTENANCE WORK

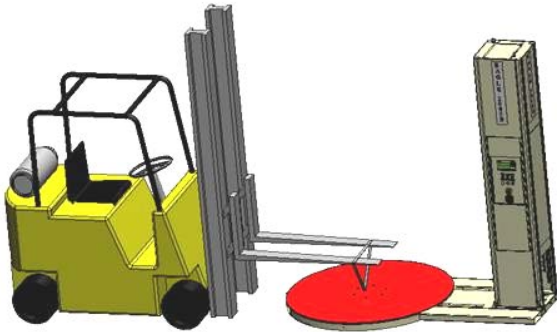

Fig. 4-1



Fig. 4-2

Turntable

- Remove the six M10 flat head cap screws in the turn table.
- Screw in one M10 eyebolt rated for lifting into the tapped hole in the turn plate. Lift the turn table using a hoist and chain rated for a 500lb load.
(See Fig. 4-1)
- Lift the turntable just clear of the frame and use the forklift to remove the table. For safety reasons, keep the disk low to the ground.
- Lubricate the chain and gears. Inspect the items and clean out any debris.
- The chain and gears need lubricated every three months. (See Fig. 4-2)

Pre-Stretch Film Carriage



Fig. 4-3

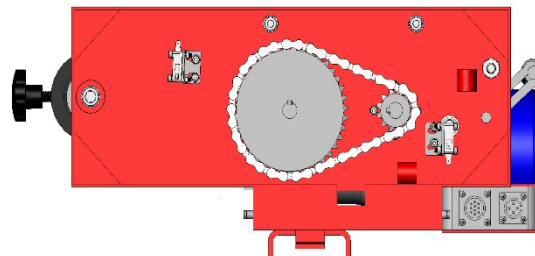

Fig. 4-3

- Lubricate the drive chain of the carriage on a monthly basis. (See Fig. 4-3)

5.3 Turntable Home Switch

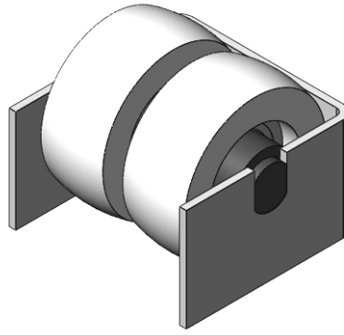

Fig. 4-4

- Remove all 24 idler wheels supporting the turntable rotation if there is excessive bearing play. If the diameter is less than 53mm or there is abnormal noise during operation, replace the bad contact rollers. (See Fig. 4-4)

	Name	Part Number
1	Shrink Ring	FG-03A-20
2	Core Holder Washer	FG-03A-21
3	Core Holder	FG-03A-19
4	Roll Holder	FG-03A-18
5	Film Tension Switch	FG-03-11
6	Idler Wheel	FG-01A-20
7	Chain	12A

5.4 Turntable & Carriage Adjustment

Test Operation

Turntable

- Turn on the power
- From the Main Menu, press;
 - ② **Job Mode**
 - ② **Manual Mode**
 - ① **Turntable** (starts turntable rotation)
 - ① **Turntable** (stops turntable rotation)
- Verify there is no play in the turntable and that the fasteners are tight.
- The chain tension controls the amount of play in the turntable. The chain should have no more than ± 0.25 " of play.
 - If greater than ± 0.25 " of play, tighten the chain using the chain adjustment screw located at the back of the frame.

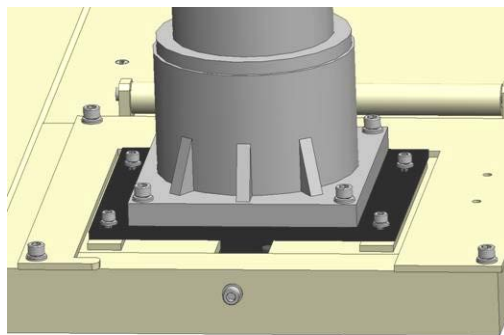

Fig. 5-1

Table Chain Adjustment

- Loosen the four holding screws of the turntable motor using a 6mm Allen Wrench.
- Turn the chain tension screw using an 8mm Allen Wrench.
 - Clockwise adjustment will tighten the chain and counter-clockwise will loosen the chain.
- After adjusting to an appropriate position, tighten the turntable motor holding screws.

Carriage Chain Adjustment

- Press ② **Up** to raise the carriage
- Press ③ **Down** to lower the carriage
- Look and listen for smooth and consistent operation. If the action is not smooth, check the carriage chain for obstructions, wear, or damage.

6.1 Illustration

Base

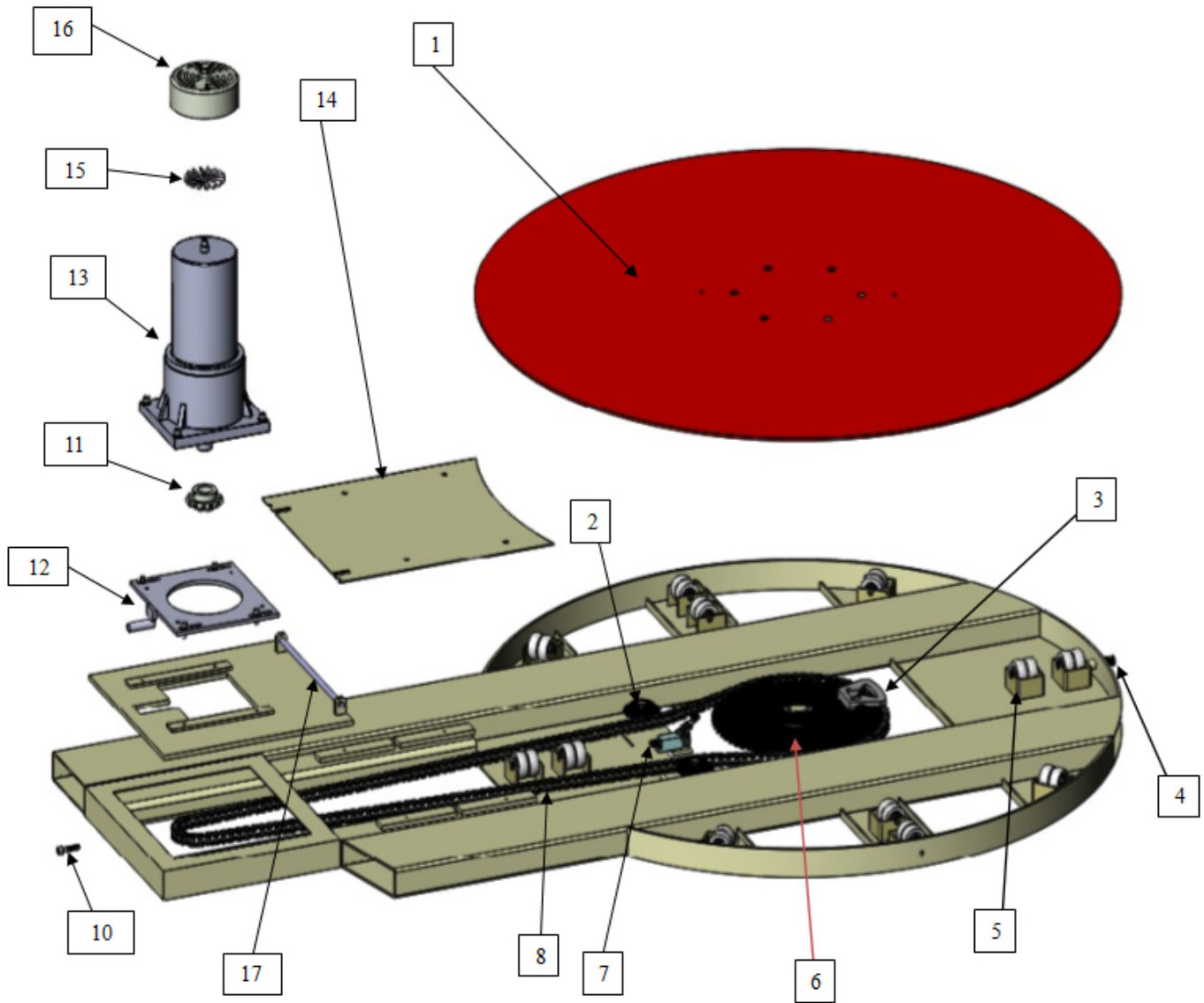

6.1 Illustration

Base (continued)

	Name	Part Number	Qty
1	Turntable	FG-01A-19	1
2	Idler Gear	FG-01A-18	2
3	Block Limit Switch	FG-12A-16	1
4	Ramp Bolt		1
5	Idler Wheel	FG-01A-20	24
6	Turntable Gear	FG-01A-13	1
7	Limit Switch	N1CA2	1
8	Chain	12A	1
9	Base Frame	n/a	1
10	Tension Screw	91292A217	1
11	Motor Gear	FG-01A-31	1
12	Motor Mount Plate	FG-01A-28	1
13	Main Motor	CV750-30S	1
14	Cover	FG-01A-27	1
15	Motor Fan Cover		1
16	Fan Motor Cover		1
17	Mast Pin		1

6.2 Illustration

Idler Wheel

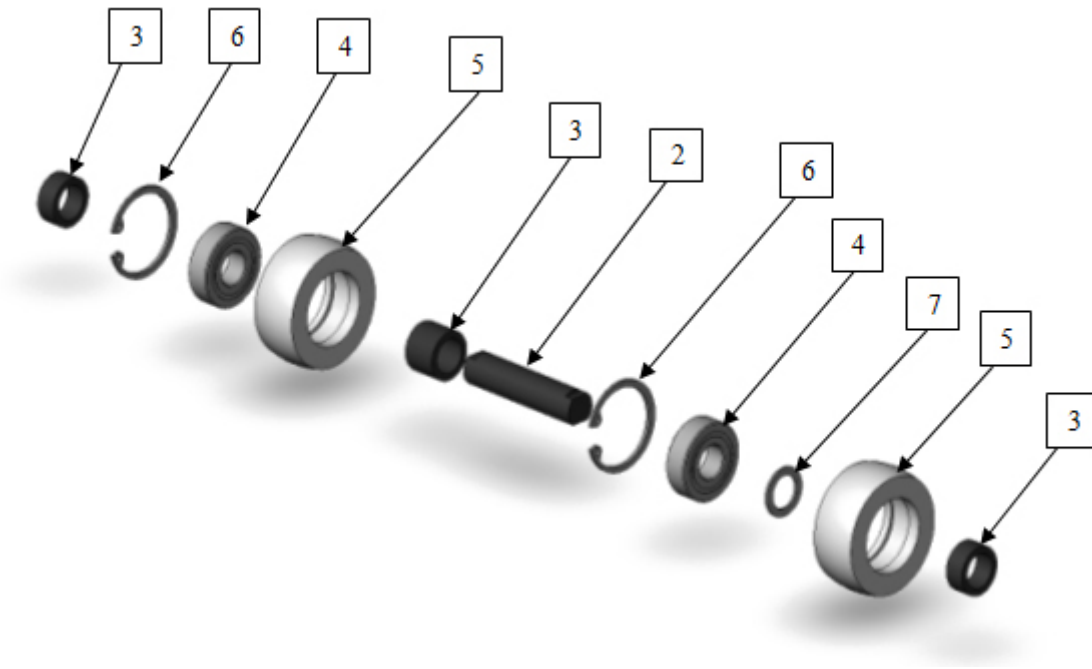

	Name	Part Number	Qty
1	Idler Wheel Bracket	n/a	12
2	Idler Wheel Axle	FG-01A-24	12
3	Idler Outer Bushing	FG-01A-23	24
4	Idler Bearing	60202	24
5	Idler Wheel	FG-01A-21	24
6	Idler Wheel Snap Ring	98455A137	24
7	Washer	98454A136	12

6.3 Illustration

Mast

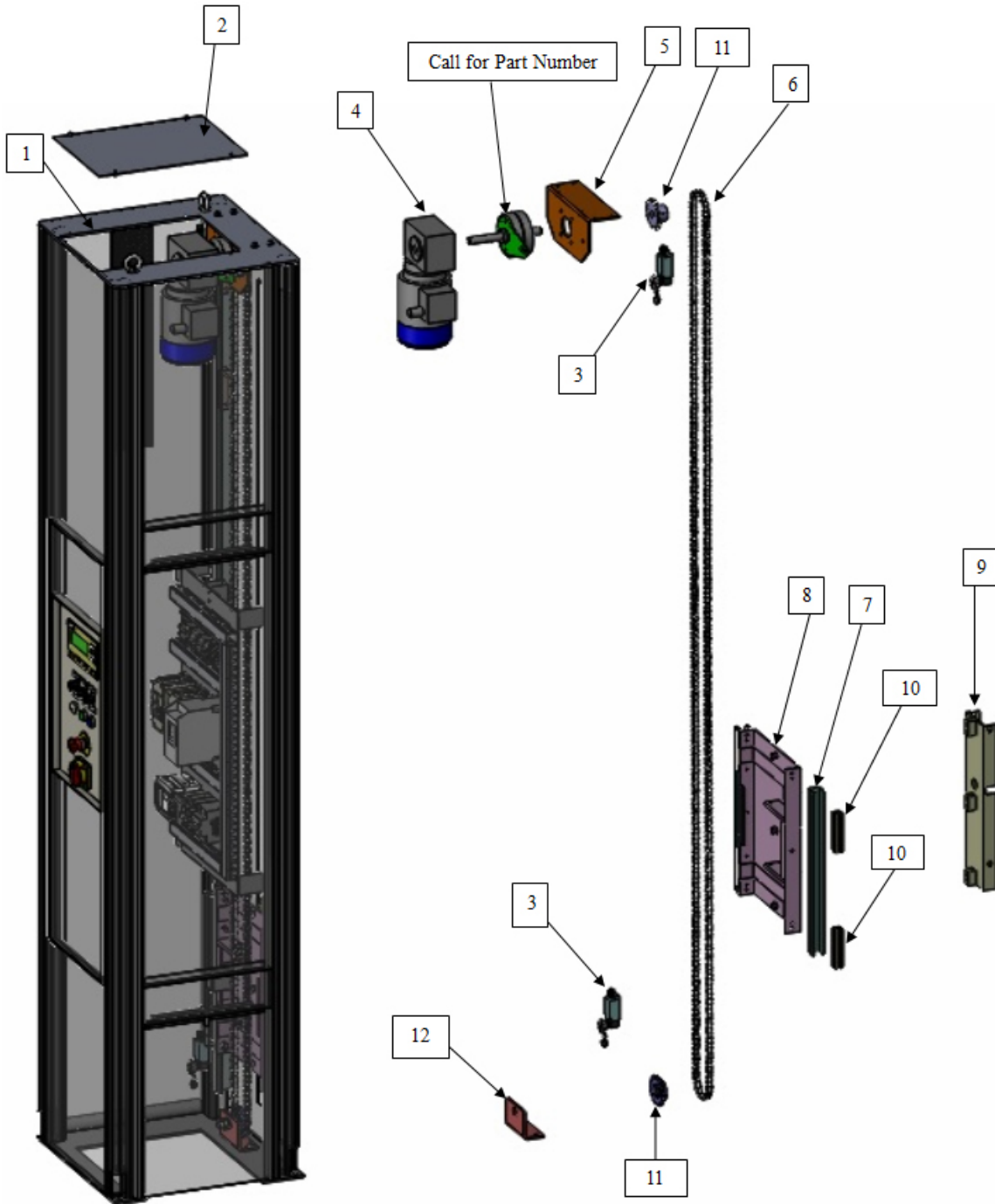

6.3 Illustration

Mast (continued)

	Name	Part Number	Qty
1	Mast (Post)	n/a	1
2	Mast Cover	FG-12-02	1
3	Upper & Lower Limit Switch	XCKP2145	2
4	Up-Down Motor	NMRV040/80-YS6344	1
5	Motor Axis	FG-12-06	1
6	Chain	08B	2
7	Slide Rail	FG-AL-01	1
8	Up-Down Shelf	FG-12-04	1
9	Transition Shelf	FG-12-05	1
10	Slide Blocks	FG-12-08	4
11	Sprocket	FG-12-07	4
12	Sprocket Bracket	FG-12-06	1

6.4 Illustration

Carriage

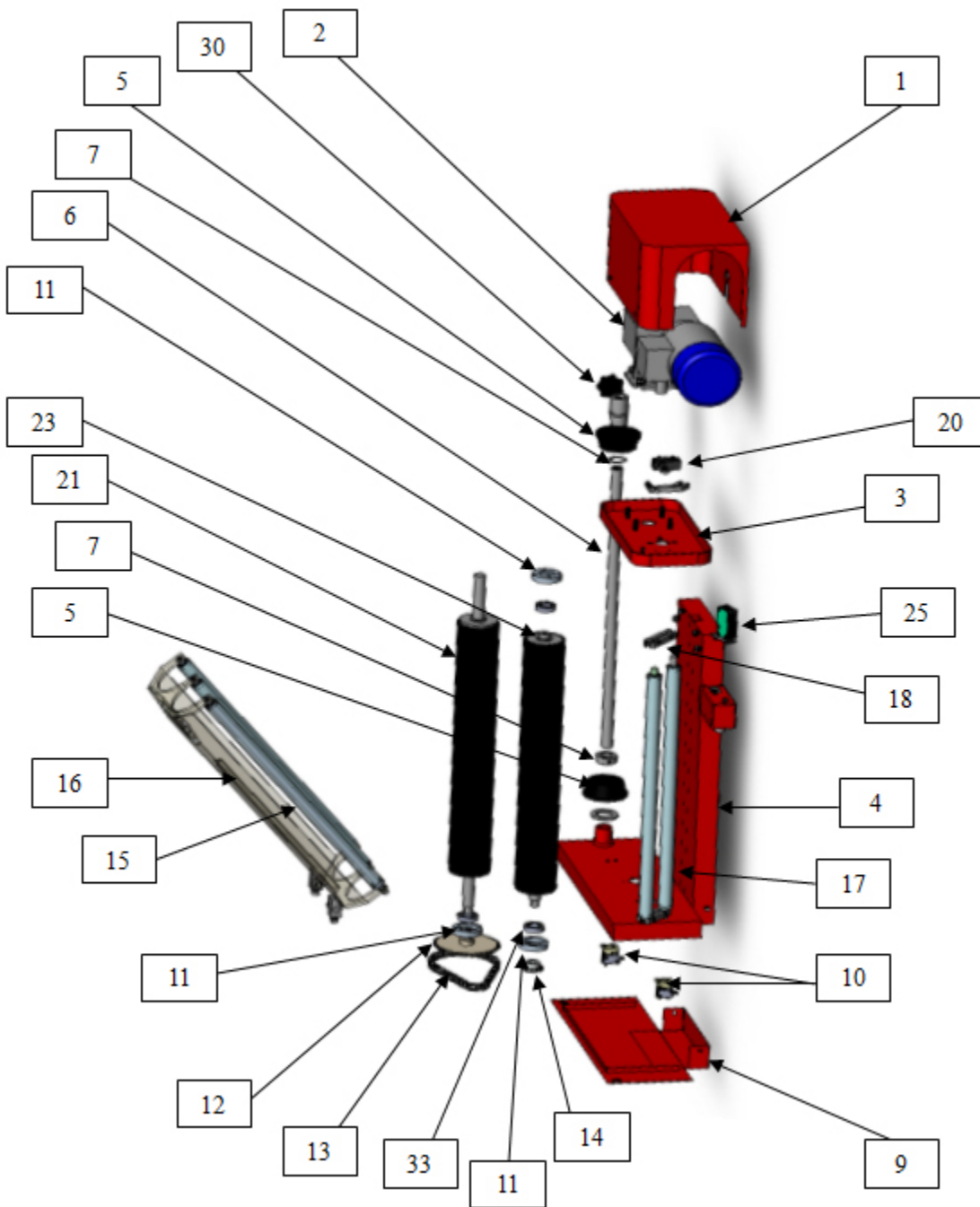

6.4 Illustration

Carriage - Continued from previous page.

	Name	Part Number	Qty
1	Motor Cover	FG-08T-20	1
2	Gear Box	NMRV40-10-YS6344	1
3	Carriage Top Plate	FG-08T-02	1
4	Film Lifter	FG-08T-00	1
5	Roll Holder	FG-03A-18	1
6	Core Holder Shaft	FG-03A-16	1
7	Core Holder Washer	FG-03A-21	1
8	Core Holder	FG-03A-19	1
9	Protection Plate/ Bottom Plate	FG-08T-16	1
10	Micro Switch	7779K22	2
11	Roller Bearing	5972K168	1
12	Large Carriage Gear	FG-03-14	1
13	Carriage Prestretch Chain	06B	1
14	Small Carriage Gear	FG-03-12	1
15	Film Roller Assembly	FG-08-07	1
16	Roller Door	FG-08-14	1
17	Extended Roller Assembly	FG-08-08	1
18	Right Connection Block	FG-08-20	1
19	Left Connection Block	FG-08-20	1
20	Film Tension Switch	FG-03-11	1
21	Main Roller	FG-03-02	1
22	Pin Release Bar Assembly	FG-08-17	1
23	Film Roller	FG-03-03	1
24	Carriage Door Bracket	FG-08-04	1
25	Photo Eye Switch	A3R-2MX	1
26	Photo Eye Bracket	FG-08-21	1
27	Spring Bolt	FG-08-18	2
28	Spring	FG-08-17	2
29	Shrink Ring	FG-03A-20	1
30	Rivet Bolt	M10	1

6.5 Illustration

Film Roller

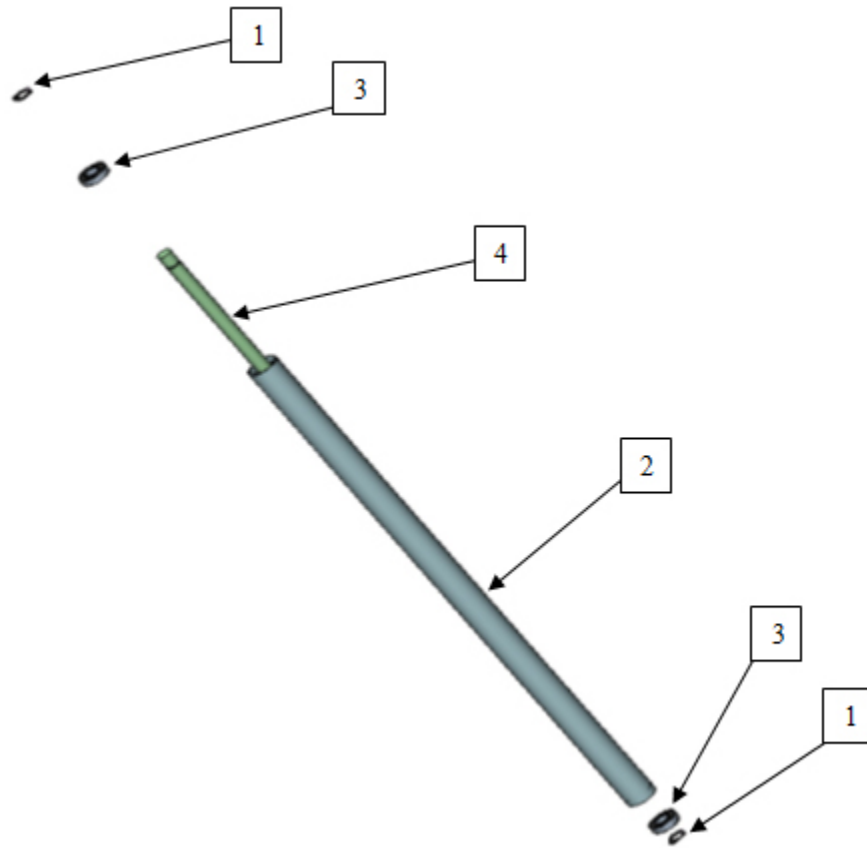

	Name	Part Number	Qty
1	E-Clip	4-MM-EC-2	2
2	Outer Tube Roll	n/a	1
3	Roller Bearing	FG-BR-02	2
4	Inner Shaft	n/a	1
5	Roller Assembly	FG-08-07	1

6.6 Illustration

Extended Roller

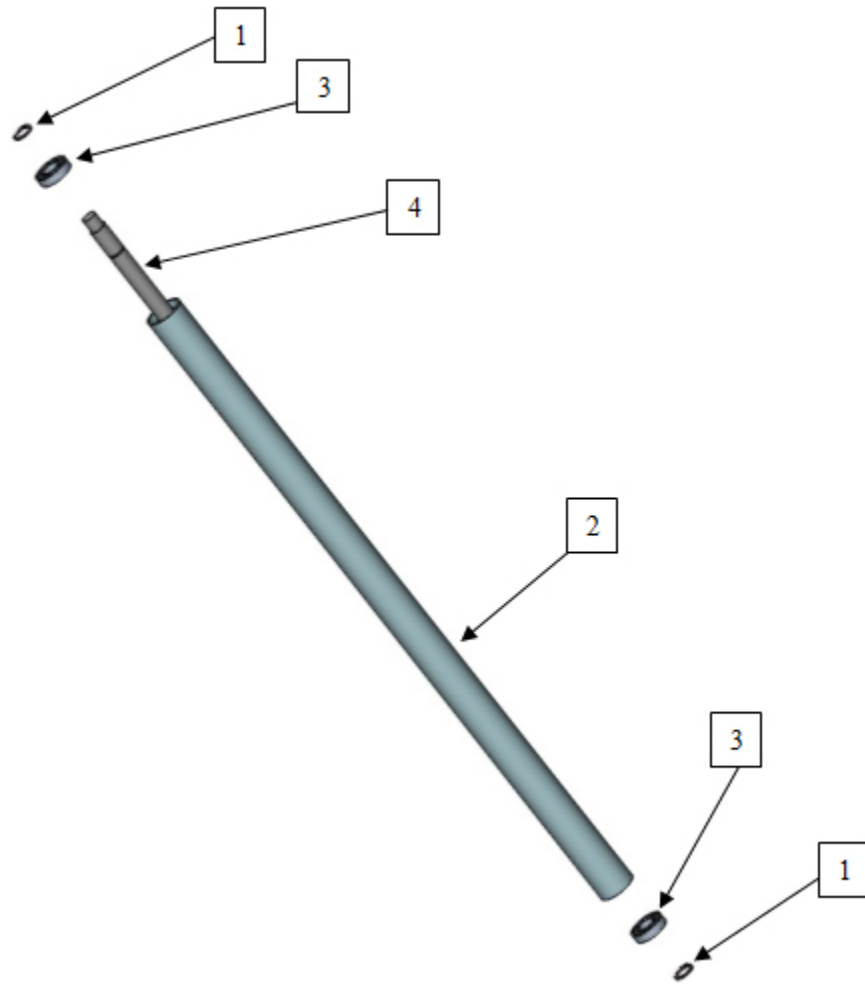

	Name	Part Number	Qty
1	E-Clip	4-MM-EC-2	2
2	Outer Tube Roll	n/a	1
3	Roller Bearing	FG-BR-02	2
4	Inner Shaft	n/a	1
5	Roller Assembly	FG-08-07	1

6.6 Motor Controls

